



USER MANUAL

Ver 1.0

Safety Notes

Thank You for Choosing Our Yacht Cam Bright!

When you open the box:

1. Check that the packing and the contents are not visibly damaged. Contact the retailer immediately if any parts are either missing or damaged.
2. Make sure if the contents are all included as per the packing list.
3. Do not attempt to use the device with missing or damaged parts. Send the product back in its original packing if it is damaged.

[Note] The information contained in the document is subject to change without notice.

Table of Contents

Safety Notes	1
About The Product	2
Features	1
Functions.....	3
Technical Data	6
Preparation	8
Dip Switch	8
Initial Power On Test.....	9
Installation Place	10
Installation	11
Fixed Mounts.....	11
Installation	12
Camera Cable Package	13
MENU SETTINGS	15
Menu Configuration	15
Menu Explanation.....	16
Operation	23
Special Control Panel Commands	23
Operation.....	24
Trouble Shooting	27
Annex: Dip Switch – Camera Address	28

Safety Notes --- Important!!!

The following important notes must be followed carefully to run the camera and respective accessories in total safety. The camera and relative accessories are called video system in this section.

- Before installing the camera, please read this manual carefully; when installing please follow instructions of installation indicated in this manual. Please keep this manual for future use.
- The following installation should be performed by qualified service personnel or system installers in accordance with all local rules.
- Before powering on the camera, please check the power voltage carefully. Make sure that you are using the right power source.
- Please put the power cable, video cable and control cable in safe place.
- Do not operate the camera beyond the specified temperature and humidity. The camera's working temperature range is between -45°C ~ $+65^{\circ}\text{C}$. The ambient humidity range is less than 95%.
- When transporting, avoid violent shake or force to the camera.
- To prevent electric shock, do not remove screws or covers of the camera. There are no self-serviceable parts inside. Refer to qualified service personnel for servicing.
- Video cable and RS485 cable should be far away from other cables. Shielded and independent wiring is necessary for video and control cables.
- Never aim the lens of the camera at the sun or other extremely bright objects. Otherwise, it may cause damage.
- When cleaning the camera, please use soft cloth. If the camera is very dirty, wipe it off gently with a soft cloth moistened with a weak solution of water and a neutral kitchen detergent. Wring all liquid from the cloth before wiping the camera, then wipe off all remaining dirt with a soft, dry cloth. Use lens cleaning paper to clean the lens.
- Do not move the camera module manually. In doing so would result in malfunction of the camera. Do not hold the camera module when carrying the video camera.
- Make sure the camera is far away from area where radiation, X-rays, strong electric waves, or magnetism is generated.

About The Product

Yacht Cam Bright is designed for fixed and mobile video surveillance applications, such as marine, law enforcement, army, border patrol, airport, oilfield etc.

It consists of: high resolution zoom module, powerful IR or white lighting module, precise system, optional damping systems.

Aux Lighting System

Powerful IR lighting or white lighting systems with ranges up to 120 meters. It ensures clear view of details in distance up to 120 meter under total dark environments.

Full Aluminum Case

The case with high strength is full weather proof, suitable for various tough applications such as rugged roads, sea, storm weather etc.

New Drive Mechanism

The Yacht Cam Bright camera employs new drive system with high precision and higher holding torque. It does not generate offset during positioning of Pan and Tilt.

Easy Installation Mounts

The new vacuum and magnetic vacuum can easily fix the Yacht Cam Bright camera firmly onto a metal surface. Meanwhile user can easily carry the Yacht Cam Bright camera with the handle at the back side.

Features

- Supports 1080P30,1080P25,1080I60,1080I59.94, 1080I50,720P60,720P50,720P30,720P25 and SD video formats;
- Aluminum case with high strength, full weather proof;
- IP index up to IP67;
- Optional damping system, for tough applications;
- Powerful IR lighting module, range up to 120 meters, auto adjust with zooms (for IR Version only);
- Powerful aux white lighting system, range up to 120 meters (for White Light Version only);
- Hidden seamless window wiper with adjustable speed;

- Camera address easily changeable via software;
- Baud rate, protocol self-adaptive;
- Digital image stabilization;
- Wide Dynamic Range (WDR);
- Day/night (ICR);
- 10.8~28V voltage input;
- Auto power-off with low power supply;

Packing List

When you open the package, please make sure below items are included. If any item is missing, please contact your supplier.

Yacht Cam Bright Camera(1)



Power Adapter(1)

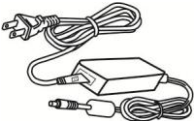

Mounting plate (1)



About The Product

Functions

Soft Address

The camera address can be programmed with a preset command, and the user does not need to dismount the camera from field or do any screw work.

Self-Adaption of Baud Rate and Protocol

The camera can automatically identify the protocol and baud rate of the controller and adapt the camera setting accordingly, with no manual DIP Switch involved.

Day/Night Function

The IR cut filter of camera module inside the camera can be removed by sending special command, so that the camera can change from color to mono.

Save/Call Preset

Preset function is that dome saves current horizontal angle and title angle of pan/tilt, zoom and position parameters into memory. When necessary dome calls these parameters and adjusts Pan/Tilt and camera to that position. User can save and call presets easily and promptly by using keyboard controller or infrared controller. The camera supports up to 256 presets.

Zoom control

User can adjust zoom wide or tele by controller and get desired image.

Focus control

System defaults Auto Focus mode, that is, the lens and camera will automatically adjust the focus to get the best image.

Focus can also be controlled manually from the controller if required. Press Focus Near or Focus Far key to manually focus. Focus can be manual via keyboard or other controller, please refer to control keyboard or other controller operation manual for detailed operation.

The camera will NOT auto focus in the following status.

- Target is not in the center of image.
- Targets are in near and far at the same time.

- Target is of strong light object. Such as spotlight etc.
- Target is behind the glass with water drop or dust.
- Target moves too fast.
- Large area target such as wall.
- Target is too dark or vague.

IRIS control

System defaults Auto IRIS. Camera can adjust immediately according to the alteration of background illumination so that a lightness steady image can be achieved.

You may adjust IRIS by controller to get required image brightness, and call back Auto IRIS by controlling the joystick.

Auto White Balance

Camera can automatically adjust white balance (WB) according to the alteration of background lightness to give a true color image.

Back Light Compensation (BLC)

If a bright backlight presents, the subjects in the picture may appear dark or as a silhouette. Backlight compensation enhances objects in the center of the picture. The camera uses the center of the picture to adjust the IRIS. If there is a bright light source outside this area, it will wash out to white. The camera will adjust the IRIS so that the object in the sensitive area is properly exposed.

Auto Cruise

The preset position is programmed to be recalled in sequence. This feature is called auto cruise.

Auto, Random and Frame Scan

Auto Scan: Make the camera scan 360° ranging from the current position.

Random Scan: Make the camera scan 360° ranging from the current position, pause at every 108°.

Frame Scan: Make the camera scan between two set positions.

[Note] For Frame Scan: The zoom at two limits shall be programmed the same.

About The Product

Image Flip

Enable you to view image easily when Yacht Cam Bright is either installed upside down or upright.

Auto Flip

When the camera tilts downward and goes just beyond the vertical angle, the camera rotates 180°. When the camera rotates (flips), the camera starts moving upward as you continue to hold joystick in the down position. Once you let go of the joystick after the dome rotates, joystick control returns to normal operation. The auto-flip feature is useful for following a person who passes directly beneath the camera.

Technical Data

Camera		
Image Sensor	1/2.8" SONY EX-View HAD CCD	
Video Format	1080P30, 1080P25, 1080I60, 1080I59.94, 1080I50, 720P60, 720P50, 720P30, 720P25	
Video System	PAL/NTSC	
Optical Zoom	30X	
Digital Zoom	12X	
Min Illumination	0.0013Lux 0.0008Lux	0.0013Lux 0.0008Lux
White Balance	Auto	
Focus	Auto/Manual	
Exposure	Auto/Manual	
S/N Ratio	Not less than 50DB	
BLC	On/Off	
WDR	Yes	
Image Stabilization	On/Off	
Digital Noise Reduction	1~5 Steps, OFF	
Day/Night	Auto(only for IR version)/Manual	
Lens	f=4.7mm~94mm F1.6 to F3.5	f=4.3mm-129mm F1.6-F4.7
View Angle	59.5° (wide) to 3.3°(tele)	63.7°(wide) to 2.3° (tele)
Yacht Cam Bright		
Pan Range	360° continuous	
Pan Speed	0.5° -80°/s, adjustable	
Tilt Range	-15°~90° with auto flip	
Tilt Speed	0.5° ~75°/s adjustable	
Preset Speed	Pan:80°/s; Tilt: 75°/s	
Preset	256	
Preset Precision	±0.2°	
Light (for IR Version)		
IR Wave Length	850nm/940nm	
IR Range	120m/60m	
IR Switch	Auto/Manual	
Light (for White Light Version)		
Color Temperature	6500K	
Range	120m	
Switch	Manual	
General		

About The Product

Comm. Interface	RS-485
OSD Language	English
Protocol	PELCO-P / PELCO-D(self-adaptive)
Baud Rate	2400bps, 4800bps, 9600bps, 19200bps (self-adaptive)
Address	0-255
Voltage	DC 10.8-28V
Power	12W (Standby) 55W (Defogger and lights on)
Working Temperature	-35°C~+65°C
IP Index	IP67
Dimensions	Standard: $\Phi 190(\text{mm}) \times 275(\text{mm})$ With Damper: $\Phi 190(\text{mm}) \times 300(\text{mm})$
Weight	Standard: 4.9kg Optional: 5.65kg (with damper)

Table 1: Technical Data

[Note] The specifications are subject to change without notice.

This section contains detailed instructions for installing the camera. These instructions assume that the installer has a good knowledge of installation techniques and is capable of adopting safe installation methods.

Dip Switch

The factory default is:

Camera Address	Protocol	Baud Rate
1	Pelco D	2400bps

The camera can detect and auto program its protocol (Pelco D, Pelco P) as well as baud rate (2400bps, 4800bps, 9600bps, 19200bps) as per the whole video system.

Only the camera address setting is necessary. There are two ways to program camera address:

- Soft address: via special preset functions (see Section 5.1 Special Control Panel Commands);
- DIP Switch: The switches to configure these settings are located on the main board inside the camera. See Fig. 1: DIP Switch.

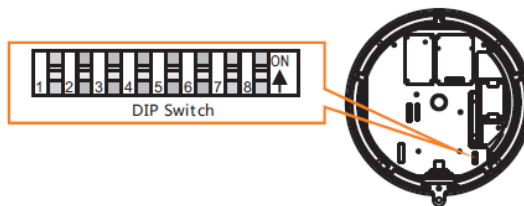

Fig. 1: DIP Switch

The setting list of the camera address is enclosed in **Annex**.

[Note] The camera shall be rebooted after the switches are programmed.

Initial Power On Test

To ensure the camera works well after installation, please power on it for an initial test with the following steps:

1. Connect the camera with correct power supply;
2. Connect control cable, video cable;
3. Power on the camera;

When the camera is powered on, the LED indicators at the front will be on.

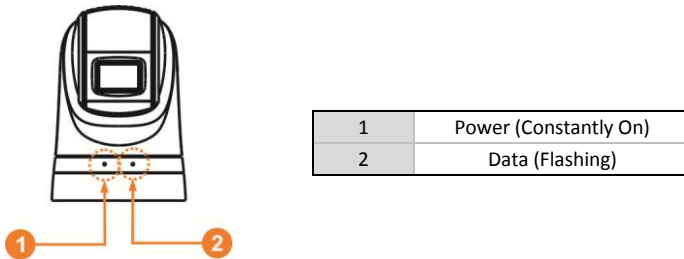

Fig. 2: LED Indicators

The camera will run a calibration procedure on power up and show the following messages on screen.

```
DOME ID: 001
PROTOCOL: PELCO-D/P
BAUD: 9600
SOFTWARE VER: 1.0.0
```

Fig. 3: On Screen Messages at Power Up

If the camera fails at initialization, the following message will show on screen.

DOME ID: 001
 PROTOCOL: PELCO-D/P
 BAUD: 9600
 SOFTWARE VER: 1.0.0

CAM FAIL

Please refer to the following code to check the failures:

PAN FAIL	Failure of pan initialization
TILT FAIL	Failure of tilt initialization
CAM FAIL	Failure of block camera initialization
P/T FAIL	Failure of pan and tilt initializations
T/Z FAIL	Failure of tilt and block camera initializations
P/T/Z FAIL	Failure of pan, tilt and block camera initializations

[Note] In case of P/T failure:

If the ambient temperature is below 5°C, the heater will be turned on automatically and the Yacht Cam Bright camera will do the initialization again.

If the ambient temperature is above 5°C, please reboot the Yacht Cam Bright camera.

Installation Place

Make sure the installation place has enough space, support strength to install the whole Yacht Cam Bright camera and its accessories.

Installation

Fixed Mounts

The fixed mount provides damping system as optional.

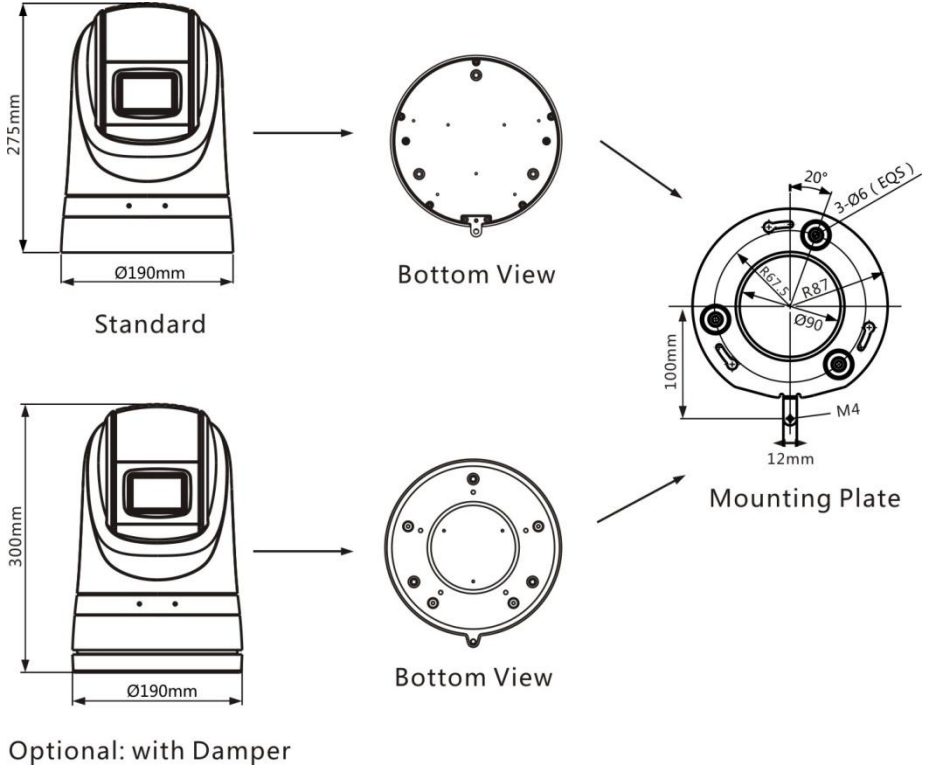

Fig. 4: Fixed Mounts (with and w/o damping system)

Installation

To set the baud rate, protocol and camera's hard address:

- 1.Remove the Yacht Cam Bright bottom plate;
- 2.Set DIP Switch for baud rate, protocol and camera address;
- 3.Fix the bottom plate. Make sure the sealing is well installed.

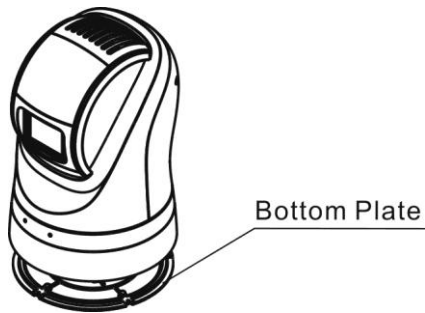

Fig. 5: Bottom Plate

- 4.Take the installation plate out of packing and fix it to the target place as per the plate dimensions with correct screws.

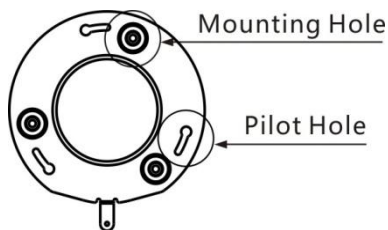

Fig. 6: Installation Plate

- 5.Put the camera onto the installation plate. Make sure three installation bolts are in position with the fixing holes on the plate. Rotate the camera clockwise.

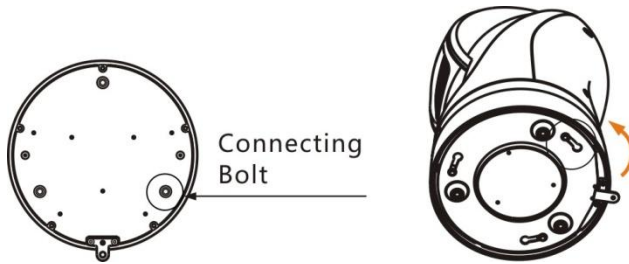

Fig. 7: Mount the Installation Plate

6. Fix the camera to the installation plate with a screw.

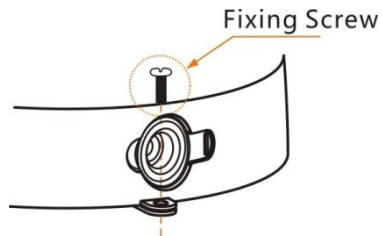

Fig. 8: Fix the Installation Plate

Camera Cable Package

Connect the cable with the right pins as per following pictures.

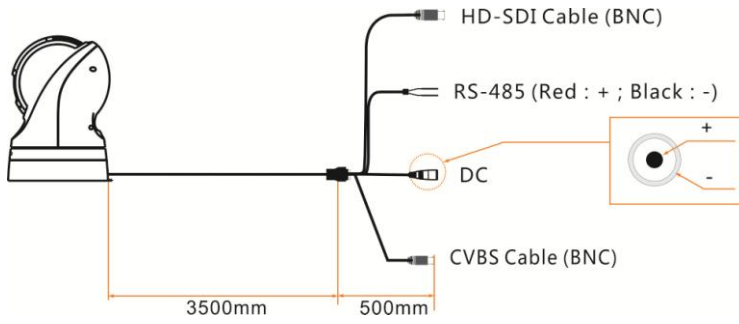

Fig. 9: Cable Package

MENU SETTINGS

Menu Configuration

<VIDEO> Refer to Page 17	FORMAT	1080I50, 1080I59.94, 1080I60, 1080P25, 1080P30, 720P50, 720P60, 720P25, 720P30
	WIDE DYNAMIC	ON, OFF, AUTO
	DNR	1, 2, 3, 4, 5, OFF
	FOCUS	MANUAL, AUTO
	FREEZE	ON, OFF
	DIGI ZOOM	ON, OFF
	DIS	ON, OFF
	EXPOSURE...	

<PAN TILT> Refer to Page 19	LIGHT	ON, OFF
	WIPER	OFF, NORMAL, FAST
	DAY/NIGHT	AUTO, DAY, NIGHT
	PRESET...	
	CRUISE...	
	FRAME SCAN...	
	RANDAM SCAN INTERVAL/S	4, 5, 6, 7, 8, 9, 10, 11, 12, 13
	POWER UP ACTION	PRESET 1~9, NONE, HOME
	PAN/TILT SPEED	1, 2, 3

<SYSTEM> Refer to Page 21	ADDRESS	0~255
	PROTOCOL	PELCO-D/P
	BAUD RATE	9600
	VIDEO FORMAT	1080I50
	MOUNT MODE	STAND
	DISPLAY INFO	ON, OFF
	SOFTWARE VER	V1.0.0

<REBOOT> Refer to page 22

<RESTORE FACTORY DEFAULTS> Refer to page 22

Menu Explanation

Main Menu

Call preset 95 to enter / exit menu.

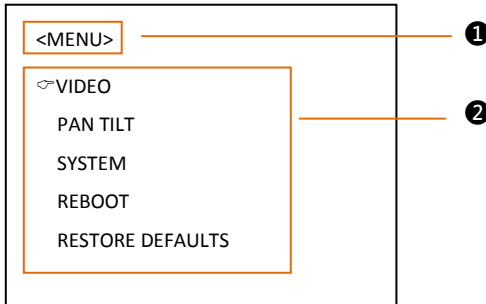

❶ Menu Title

It displays currently selected menu entries.

❷ Menu Entries

It displays options under current menu title.

Press ▲ or ▼ button to select among menu options, once font of options turned from white color to yellow color, it indicates the menu has been elected, press **OPEN** button to get into this menu.

VIDEO

VIDEO menu is used to change video value.

<VIDEO>	
FORMAT	1080P25
WIDE DYNAMIC	OFF
DNR	5
FOCUS	AUTO
FREEZE	OFF
DIGI ZOOM	OFF
DIS	OFF
EXPOSURE...	

Option	Value	Explanation
FORMAT	1080I50, 1080I59.94, 1080I60, 1080Pp25, 1080P30, 720P50, 720P60,720P25, 720P30	When HD video output format is set as 1080I60, 1080I59.94, 720P60, 1080P30, 720P30, relative SD video format is NTSC; When HD video output format is set as 1080I50, 720P50, 1080P25, 720P25, relative SD video format is PAL.
WIDE DYNAMIC	ON, OFF, AUTO	Switch wide dynamic mode.
DNR	1, 2, 3, 4, 5, OFF	If camera displays color image, it is suggested to turn off the DNR level, otherwise, the video trails will be generated. The higher the level is, the better is the noise reduction performance, but more video trails will be generated.
FOCUS	AUTO, MANUAL	Switch focus mode ON or OFF,
FREEZE	ON, OFF	Switch image freeze ON or OFF.
DIGI ZOOM	ON, OFF	Switch digital zoom ON or OFF.
DIS	ON, OFF	Switch digital image stabilization ON or OFF.
EXPOSURE...	-	Automatic exposure submenu

EXPOSURE

<EXPOSURE>	
☞MODE	FULL AUTO
SLOW SHT.LIMIT	OFF

Option	Value	Explanation
MODE	FULL AUTO, MANUAL, SHUTTER PRI, IRIS PRI	Switch exposure mode.

FULL AUTO: Gain, Shutter Speed and Iris value are adjusted automatically accordingly to working environment.

SLOW SHT. LIMIT: this option sits under "Full Auto", there are On and Off options.

MANUAL: manually adjust Gain, Shutter Speed and Iris

GAIN: -3, 0, +2, +4, +6, +8, +10, +12, +14, +16, +18, +20, +22, +24, +26, +28.

SPEED: 1/1, 1/2, 1/3, 1/6, 1/12, 1/25, 1/50, 1/75, 1/100, 1/120, 1/150, 1/215, 1/300, 1/425, 1/600, 1/1000, 1/1250, 1/1750, 1/2500, 1/3500, 1/6000, 1/10000s.

IRIS: F14, F11, F9.6, F8, F6.8, F5.6, F4.8, F4, F3.4, F2.8, F2.4, F2, F1.6, CLOSE.

SHUTTER PRI: Gain and Iris value are adjusted automatically according to working environment; shutter speed value is adjustable manually.

SPEED: 1/1, 1/2, 1/3, 1/6, 1/12, 1/25, 1/50, 1/75, 1/100, 1/120, 1/150, 1/215, 1/300, 1/425, 1/600, 1/1000, 1/1250, 1/1750, 1/2500, 1/3500, 1/6000, 1/10000s.

IRIS PRI: Gain and shutter speed value are adjusted automatically according to working environment; Iris value is adjustable manually.

IRIS: F14, F11, F9.6, F8, F6.8, F5.6, F4.8, F4, F3.4, F2.8, F2.4, F2, F1.6, CLOSE.

PAN TILT

PAN/TILT is used to change pan/tilt/zoom value, available options:

<PAN TILT>	
☞ LIGHT	OFF
WIPER	OFF
DAY/NIGHT	AUTO
PRESET...	
CRUISE...	
FRAME SCAN...	
RANDOM SCAN INTERVAL/S	6
POWER UP ACTION	NONE
PAN/TILT SPEED	2

Option	Value	Explanation
LIGHT	ON, OFF	This option sits under manual DAY/NIGHT
WIPER	OFF, NORMAL, FAST	Default wiper setting is OFF.
DAY/NIGHT	AUTO, DAY, NIGHT	Switch DAY/NIGHT mode.
PRESET...	-	Preset parameter submenu
CRUISE...	-	Cruise parameter programming submenu
FRAME SCAN...	-	Frame scan parameter programming submenu.
RANDOM SCAN INTERVAL/S	4, 5, 6, 7, 8, 9, 10, 11, 12, 13	Setting interval of random scan.
POWER UP ACTION	PRESET 1~9, NONE, HOME	The action is performed after powered up
PAN/TILT SPEED	1, 2, 3	Setting pan/tilt speed.

 If preset 0 has been saved, after powered on, camera moves to preset 0 automatically; if preset 0 has not been saved, after powered on, camera moves to Home position, where both pan and tilt angle is zero and zooming time is 1x.

PRESET

<PRESET>	
☞ NUM	1
PAN	
TILT	
ZOOM	
LABEL	
EDIT	NO
DELETE	NO

Option	Value	Explanation
NUM	0~255	Preset number
PAN	System information	Pan position
TILT	System information	Tilt position
ZOOM	System information	Zoom position
LABEL	System information	Preset label
EDIT	YES, NO	Edit preset
DELETE	YES, NO	Delete preset

<EDIT> : Point the cursor to the **EDIT** by moving the joystick vertically. Choose **YES** by moving the joystick right, the instruction will pop up:

<PRESET EDIT>
CLICK IRIS OPEN CONFIRM
CLICK IRIS CLOSE CANCEL

Press **OPEN**, moving up/down/left/right and zoom of the camera to set preset.

CRUISE

<CRUISE>	
☞ PATH	1
INTERVAL/S	6
SELECT PRESET TO CRUISE	
2 3 4 5 7 8 9 10 12	
^ ^ ^ ^ ^ ^	

Menu settings

Option	Value	Explanation
PATH	1, 2, 3, 4	-
INTERVAL/S	4~13s	Duration (in seconds) of the dwelling time on each preset.
SELECT PRESET TO CRUISE	System information	This menu item is used to enable each of the preset positions used in the cruise cycle.

SELECT PRESET TO CRUISE: Move joystick to preset number, press **OPEN**, the symbol “^” under the number will be disappeared, Indicating present preset is not available in the cruise cycle. Press **OPEN** again, the symbol will appear.

FRAME SCAN

<FRAME SCAN>	
↵INTERVAL/S	1
EDIT	NO
DELETE	NO

Option	Value	Explanation
INTERVAL/S	4~13s	Setting interval of frame scan.
EDIT	YES, NO	Edit the preset of frame scan.
DELETE	YES, NO	Delete the preset of frame scan.

SYSTEM

SYSTEM displays current camera's address, protocol, baud rate, video format, mount mode and software version number.

<SYSTEM>	
↵ADDRESS	1
PROTOCOL	PELCO-D/P
BAUD RATE	9600
VIDEO FORMAT	1080P30
MOUNT MODE	STAND
DISPLAY INFO	ON
SOFTWARE VER	V1.0.0

Option	Value	Explanation
ADDRESS	0~255	Reboot is necessary after switch.
PROTOCOL	System information	-
BAUDRATE	System information	-
VIDEO FORMAT	System information	-
MOUNT MODE	CEILING, STAND	-
DISPLAY INFO	ON, OFF	Show or hide the information of camera
SOFTWARE VER	System information	-

REBOOT

Choose REBOOT option, press **OPEN** to confirm, the indication will appear:

<REBOOT>
 CLICK IRIS OPEN TO CONFIRM
 CLICK IRIS CLOSE TO CANCEL

RESTORE FACTORY DEFAULTS

This menu is to resume the camera or all ptz parameters to factory default.

<RESTORE FACTORY DEFAULTS>
 CLICK IRIS OPEN TO CONFIRM RESTORE
 FAOTORY DEFAULT
 CLICK IRIS CLOSE TO CANCEL

Operation

Special Control Panel Commands

The camera can be programmed and operated using various quick control panel commands.

Preset Number	Function	Default Value
GO TO 21	Manual switch between color mode (with light off) and mono mode (with light on)	***
GO TO 22	Auto switch between color mode (with IR off) and mono mode (with IR on), for IR Version only	√
GO TO 23	Turn on/off Wide Dynamic Range (WDR)	Off
GO TO 24	Auto WDR	Off
GO TO 25	Turn on/off Back Light Compensation (BLC)	Off
GO TO 26	Turn on/off Image Flip	Off
GO TO 27	Turn on/off Digital Noise Reduction (DNR, 1-3/5steps)	Off
GO TO 28	Turn on/off video freeze	Off
GO TO 29	Turn on/off Digital Image Stabilization (DIS)	Off
GO TO 30	Turn on lights only (only for IR)	***
GO TO 31	Turn off lights only (only for IR)	√
GO TO 34	Fast wiper (Do not attempt to activate wiper when there is no water on the glass)	***
GO TO 35	Normal wiper (Do not attempt to activate wiper when there is no water on the glass)	***
GO TO 36	Turn off wiper	√
GO TO 37	Turn on defogger	***
GO TO 38	Turn off defogger	√
GO TO 39	Turn on/off digital zoom	Off
GO TO 40	Turn on/off on screen display	On
GO TO 42	Set Left Boundary Of Frame Scan	***
GO TO 43	Set Right Boundary Of Frame Scan	***
GO TO 48	Turn on random scan	***
GO TO 49	Turn on frame scan between two set presets	***
GO TO 50	Turn on cruise 1	***
GO TO 51	Turn on Auto Scan(360° Scan)	***
GO TO 52	Clear all Presets	***
GO TO 53	Restore factory default and reboot the camera	***
GO TO 57	Turn On/Off Screen Tips / Page Down Of Screen Tips	***
GO TO 59	Yacht Cam Bright Speed - Fast	***
GO TO 60	Yacht Cam Bright speed - Normal	√
GO TO 61	Yacht Cam Bright speed - Slow	***
GO TO 62	Decrease the camera Address By -1	***
GO TO 63	Increase the camera Address By +1	***
GO TO 64	Auto shutter	***

GO TO 65	Increase the camera shutter speed	***
GO TO 66	Decrease the camera shutter speed	***
GO TO 67	Turn on cruise 2	***
GO TO 68	Turn on cruise 3	***
GO TO 69	Turn on cruise 4	***
GO TO 70	Turn on white lights only (only for white light models)	***
GO TO 71	Turn on white lights only (only for white light models)	√
GO TO 95	Enter menu	***

Table 2 Special Commands

Operation

As the baud rate and protocol are self-adaptive, the Yacht Cam Bright cameras may not response for seconds on power up. It is recognizing the commands and adapting the setting.

IR / White Light

Auto Mode (For IR Version Only):

The default IR mode is auto. Auto mode can also be activated via preset 22. At this mode, the commands of preset 30, 31 are disabled.

When the zoom module is in mono, the camera will automatically turn on IR lights. The high beam and low beam will be turned on/off as per the current zoom times.

When the module is in color mode, the camera will automatically turn off IR lights.

Manual Mode:

Call Preset 21 to turn on the manual mode. The module will be switched into color or mono mode. And lights can be controlled via the commands of presets 30, 31.

[Note] When the ambient temperature is above +50°C, the aux lighting system is suggested to be turned off to protect the Yacht Cam Bright cameras.

Image Freeze

Call Preset 28 to turn on/off the function. When it is on, during a regular preset call (see following picture), the video will be frozen at point A till Point B. At Point B, the video will be displayed normally.

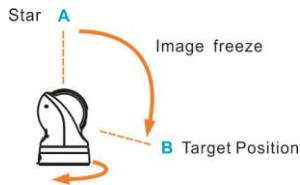

Fig. 10: Image Freeze

Defogging

Call Preset 37 to turn on the function. There will be “DEFOGGING” flashing at top of the screen. When the fog is cleared, turn off the function in time in case the camera temperature is getting too high.

Call Preset 38 to turn off the function. The “DEFOGGING” at top of the screen will disappear from the screen.

If the defogger is on, once temperature inside the camera reaches +55 degree, the defogger will be turned off automatically;

If the defogger is off, once temperature inside the camera is lower than +10 degree, the defogger will be turned on automatically.

Soft Address

The camera address can be changed via presets 62 and 63. The new address will take effect after the camera is rebooted.

Digital Image Stabilization (DIS)

The function is off as default. It can be turned on/off by calling preset 29.

It is used when the camera is used in a vibration environment, to compensate the vibration in video (Some configuration does not support).

Digital Noise Reduction

The function is off as default.

When the camera is in color mode, it is recommended to turn off the function, or there will be video trails.

When the camera is in mono mode, call preset 27 to turn on/off the function. There are 1~5 steps from low to high. The higher the level is, the more video trails there are.

Wiper

For proper use of wiper, do not attempt to activate it when there is no water on the glass.

Trouble Shooting

Problems	Possible Causes	Solutions
No action when powered on	Power supply failure	Replace power supply
	Wrong connection of the power	Check & reconnect the cables
Abnormal self-test with motor noise	Mechanical failure	Repair
	Camera inclined	Reinstall the camera
	Inadequate power supply	Replace the power supply
Normal self-test but no images	Video signal failure	Reinstall camera
	Wrong connection of the video	Check & reconnect the cables
	Camera damaged	Replace the camera
Normal self-test but out of control	Wrong connection of RS485 cable	Check and reconnect the cable
	Wrong camera address set	Check and reset the Switches
Vague image	Bad connection of the video	Check and reconnect the cables
	Inadequate power supply	Replace the power supply
Yacht Cam Bright camera out of control	Self test error	Restart the camera
	Wrong connection of RS485 cable	Check and reconnect the cables

Table 3 Trouble Shooting

Annex: DIP Switch – Camera Address

ADDRESS	1	2	3	4	5	6	7	8
0	OFF	OFF	OFF	OFF	OFF	OFF	OFF	OFF
1	ON	OFF	OFF	OFF	OFF	OFF	OFF	OFF
2	OFF	ON	OFF	OFF	OFF	OFF	OFF	OFF
3	ON	ON	OFF	OFF	OFF	OFF	OFF	OFF
4	OFF	OFF	ON	OFF	OFF	OFF	OFF	OFF
5	ON	OFF	ON	OFF	OFF	OFF	OFF	OFF
6	OFF	ON	ON	OFF	OFF	OFF	OFF	OFF
7	ON	ON	ON	OFF	OFF	OFF	OFF	OFF
8	OFF	OFF	OFF	ON	OFF	OFF	OFF	OFF
9	ON	OFF	OFF	ON	OFF	OFF	OFF	OFF
10	OFF	ON	OFF	ON	OFF	OFF	OFF	OFF
11	ON	ON	OFF	ON	OFF	OFF	OFF	OFF
12	OFF	OFF	ON	ON	OFF	OFF	OFF	OFF
13	ON	OFF	ON	ON	OFF	OFF	OFF	OFF
14	OFF	ON	ON	ON	OFF	OFF	OFF	OFF
15	ON	ON	ON	ON	OFF	OFF	OFF	OFF
16	OFF	OFF	OFF	OFF	ON	OFF	OFF	OFF
17	ON	OFF	OFF	OFF	ON	OFF	OFF	OFF
18	OFF	ON	OFF	OFF	ON	OFF	OFF	OFF
19	ON	ON	OFF	OFF	ON	OFF	OFF	OFF
20	OFF	OFF	ON	OFF	ON	OFF	OFF	OFF
21	ON	OFF	ON	OFF	ON	OFF	OFF	OFF
22	OFF	ON	ON	OFF	ON	OFF	OFF	OFF
23	ON	ON	ON	OFF	ON	OFF	OFF	OFF
24	OFF	OFF	OFF	ON	ON	OFF	OFF	OFF
25	ON	OFF	OFF	ON	ON	OFF	OFF	OFF
26	OFF	ON	OFF	ON	ON	OFF	OFF	OFF
27	ON	ON	OFF	ON	ON	OFF	OFF	OFF
28	OFF	OFF	ON	ON	ON	OFF	OFF	OFF
29	ON	OFF	ON	ON	ON	OFF	OFF	OFF
30	OFF	ON	ON	ON	ON	OFF	OFF	OFF
31	ON	ON	ON	ON	ON	OFF	OFF	OFF
32	OFF	OFF	OFF	OFF	OFF	ON	OFF	OFF
33	ON	OFF	OFF	OFF	OFF	ON	OFF	OFF
34	OFF	ON	OFF	OFF	OFF	ON	OFF	OFF
35	ON	ON	OFF	OFF	OFF	ON	OFF	OFF
36	OFF	OFF	ON	OFF	OFF	ON	OFF	OFF
37	ON	OFF	ON	OFF	OFF	ON	OFF	OFF
38	OFF	ON	ON	OFF	OFF	ON	OFF	OFF

ANNEX: DIP SWITCH – CAMERA ADDRESS

39	ON	ON	ON	OFF	OFF	ON	OFF	OFF
40	OFF	OFF	OFF	ON	OFF	ON	OFF	OFF
41	ON	OFF	OFF	ON	OFF	ON	OFF	OFF
42	OFF	ON	OFF	ON	OFF	ON	OFF	OFF
43	ON	ON	OFF	ON	OFF	ON	OFF	OFF
44	OFF	OFF	ON	ON	OFF	ON	OFF	OFF
45	ON	OFF	ON	ON	OFF	ON	OFF	OFF
46	OFF	ON	ON	ON	OFF	ON	OFF	OFF
47	ON	ON	ON	ON	OFF	ON	OFF	OFF
48	OFF	OFF	OFF	OFF	ON	ON	OFF	OFF
49	ON	OFF	OFF	OFF	ON	ON	OFF	OFF
50	OFF	ON	OFF	OFF	ON	ON	OFF	OFF
51	ON	ON	OFF	OFF	ON	ON	OFF	OFF
52	OFF	OFF	ON	OFF	ON	ON	OFF	OFF
53	ON	OFF	ON	OFF	ON	ON	OFF	OFF
54	OFF	ON	ON	OFF	ON	ON	OFF	OFF
55	ON	ON	ON	OFF	ON	ON	OFF	OFF
56	OFF	OFF	OFF	ON	ON	ON	OFF	OFF
57	ON	OFF	OFF	ON	ON	ON	OFF	OFF
58	OFF	ON	OFF	ON	ON	ON	OFF	OFF
59	ON	ON	OFF	ON	ON	ON	OFF	OFF
60	OFF	OFF	ON	ON	ON	ON	OFF	OFF
61	ON	OFF	ON	ON	ON	ON	OFF	OFF
62	OFF	ON	ON	ON	ON	ON	OFF	OFF
63	ON	ON	ON	ON	ON	ON	OFF	OFF
64	OFF	OFF	OFF	OFF	OFF	OFF	ON	OFF
65	ON	OFF	OFF	OFF	OFF	OFF	ON	OFF
66	OFF	ON	OFF	OFF	OFF	OFF	ON	OFF
67	ON	ON	OFF	OFF	OFF	OFF	ON	OFF
68	OFF	OFF	ON	OFF	OFF	OFF	ON	OFF
69	ON	OFF	ON	OFF	OFF	OFF	ON	OFF
70	OFF	ON	ON	OFF	OFF	OFF	ON	OFF
71	ON	ON	ON	OFF	OFF	OFF	ON	OFF
72	OFF	OFF	OFF	ON	OFF	OFF	ON	OFF
73	ON	OFF	OFF	ON	OFF	OFF	ON	OFF
74	OFF	ON	OFF	ON	OFF	OFF	ON	OFF
75	ON	ON	OFF	ON	OFF	OFF	ON	OFF
76	OFF	OFF	ON	ON	OFF	OFF	ON	OFF
77	ON	OFF	ON	ON	OFF	OFF	ON	OFF
78	OFF	ON	ON	ON	OFF	OFF	ON	OFF

ANNEX: DIP SWITCH – CAMERA ADDRESS

79	ON	ON	ON	ON	OFF	OFF	ON	OFF
80	OFF	OFF	OFF	OFF	ON	OFF	ON	OFF
81	ON	OFF	OFF	OFF	ON	OFF	ON	OFF
82	OFF	ON	OFF	OFF	ON	OFF	ON	OFF
83	ON	ON	OFF	OFF	ON	OFF	ON	OFF
84	OFF	OFF	ON	OFF	ON	OFF	ON	OFF
85	ON	OFF	ON	OFF	ON	OFF	ON	OFF
86	OFF	ON	ON	OFF	ON	OFF	ON	OFF
87	ON	ON	ON	OFF	ON	OFF	ON	OFF
88	OFF	OFF	OFF	ON	ON	OFF	ON	OFF
89	ON	OFF	OFF	ON	ON	OFF	ON	OFF
90	OFF	ON	OFF	ON	ON	OFF	ON	OFF
91	ON	ON	OFF	ON	ON	OFF	ON	OFF
92	OFF	OFF	ON	ON	ON	OFF	ON	OFF
93	ON	OFF	ON	ON	ON	OFF	ON	OFF
94	OFF	ON	ON	ON	ON	OFF	ON	OFF
95	ON	ON	ON	ON	ON	OFF	ON	OFF
96	OFF	OFF	OFF	OFF	OFF	ON	ON	OFF
97	ON	OFF	OFF	OFF	OFF	ON	ON	OFF
98	OFF	ON	OFF	OFF	OFF	ON	ON	OFF
99	ON	ON	OFF	OFF	OFF	ON	ON	OFF
100	OFF	OFF	ON	OFF	OFF	ON	ON	OFF
101	ON	OFF	ON	OFF	OFF	ON	ON	OFF
102	OFF	ON	ON	OFF	OFF	ON	ON	OFF
103	ON	ON	ON	OFF	OFF	ON	ON	OFF
104	OFF	OFF	OFF	ON	OFF	ON	ON	OFF
105	ON	OFF	OFF	ON	OFF	ON	ON	OFF
106	OFF	ON	OFF	ON	OFF	ON	ON	OFF
107	ON	ON	OFF	ON	OFF	ON	ON	OFF
108	OFF	OFF	ON	ON	OFF	ON	ON	OFF
109	ON	OFF	ON	ON	OFF	ON	ON	OFF
110	OFF	ON	ON	ON	OFF	ON	ON	OFF
111	ON	ON	ON	ON	OFF	ON	ON	OFF
112	OFF	OFF	OFF	OFF	ON	ON	ON	OFF
113	ON	OFF	OFF	OFF	ON	ON	ON	OFF
114	OFF	ON	OFF	OFF	ON	ON	ON	OFF
115	ON	ON	OFF	OFF	ON	ON	ON	OFF
116	OFF	OFF	ON	OFF	ON	ON	ON	OFF
117	ON	OFF	ON	OFF	ON	ON	ON	OFF
118	OFF	ON	ON	OFF	ON	ON	ON	OFF

ANNEX: DIP SWITCH – CAMERA ADDRESS

119	ON	ON	ON	OFF	ON	ON	ON	OFF
120	OFF	OFF	OFF	ON	ON	ON	ON	OFF
121	ON	OFF	OFF	ON	ON	ON	ON	OFF
122	OFF	ON	OFF	ON	ON	ON	ON	OFF
123	ON	ON	OFF	ON	ON	ON	ON	OFF
124	OFF	OFF	ON	ON	ON	ON	ON	OFF
125	ON	OFF	ON	ON	ON	ON	ON	OFF
126	OFF	ON	ON	ON	ON	ON	ON	OFF
127	ON	ON	ON	ON	ON	ON	ON	OFF
128	OFF	OFF	OFF	OFF	OFF	OFF	OFF	ON
129	ON	OFF	OFF	OFF	OFF	OFF	OFF	ON
130	OFF	ON	OFF	OFF	OFF	OFF	OFF	ON
131	ON	ON	OFF	OFF	OFF	OFF	OFF	ON
132	OFF	OFF	ON	OFF	OFF	OFF	OFF	ON
133	ON	OFF	ON	OFF	OFF	OFF	OFF	ON
134	OFF	ON	ON	OFF	OFF	OFF	OFF	ON
135	ON	ON	ON	OFF	OFF	OFF	OFF	ON
136	OFF	OFF	OFF	ON	OFF	OFF	OFF	ON
137	ON	OFF	OFF	ON	OFF	OFF	OFF	ON
138	OFF	ON	OFF	ON	OFF	OFF	OFF	ON
139	ON	ON	OFF	ON	OFF	OFF	OFF	ON
140	OFF	OFF	ON	ON	OFF	OFF	OFF	ON
141	ON	OFF	ON	ON	OFF	OFF	OFF	ON
142	OFF	ON	ON	ON	OFF	OFF	OFF	ON
143	ON	ON	ON	ON	OFF	OFF	OFF	ON
144	OFF	OFF	OFF	OFF	ON	OFF	OFF	ON
145	ON	OFF	OFF	OFF	ON	OFF	OFF	ON
146	OFF	ON	OFF	OFF	ON	OFF	OFF	ON
147	ON	ON	OFF	OFF	ON	OFF	OFF	ON
148	OFF	OFF	ON	OFF	ON	OFF	OFF	ON
149	ON	OFF	ON	OFF	ON	OFF	OFF	ON
150	OFF	ON	ON	OFF	ON	OFF	OFF	ON
151	ON	ON	ON	OFF	ON	OFF	OFF	ON
152	OFF	OFF	OFF	ON	ON	OFF	OFF	ON
153	ON	OFF	OFF	ON	ON	OFF	OFF	ON
154	OFF	ON	OFF	ON	ON	OFF	OFF	ON
155	ON	ON	OFF	ON	ON	OFF	OFF	ON
156	OFF	OFF	ON	ON	ON	OFF	OFF	ON
157	ON	OFF	ON	ON	ON	OFF	OFF	ON
158	OFF	ON	ON	ON	ON	OFF	OFF	ON

ANNEX: DIP SWITCH – CAMERA ADDRESS

159	ON	ON	ON	ON	ON	OFF	OFF	ON
160	OFF	OFF	OFF	OFF	OFF	ON	OFF	ON
161	ON	OFF	OFF	OFF	OFF	ON	OFF	ON
162	OFF	ON	OFF	OFF	OFF	ON	OFF	ON
163	ON	ON	OFF	OFF	OFF	ON	OFF	ON
164	OFF	OFF	ON	OFF	OFF	ON	OFF	ON
165	ON	OFF	ON	OFF	OFF	ON	OFF	ON
166	OFF	ON	ON	OFF	OFF	ON	OFF	ON
167	ON	ON	ON	OFF	OFF	ON	OFF	ON
168	OFF	OFF	OFF	ON	OFF	ON	OFF	ON
169	ON	OFF	OFF	ON	OFF	ON	OFF	ON
170	OFF	ON	OFF	ON	OFF	ON	OFF	ON
171	ON	ON	OFF	ON	OFF	ON	OFF	ON
172	OFF	OFF	ON	ON	OFF	ON	OFF	ON
173	ON	OFF	ON	ON	OFF	ON	OFF	ON
174	OFF	ON	ON	ON	OFF	ON	OFF	ON
175	ON	ON	ON	ON	OFF	ON	OFF	ON
176	OFF	OFF	OFF	OFF	ON	ON	OFF	ON
177	ON	OFF	OFF	OFF	ON	ON	OFF	ON
178	OFF	ON	OFF	OFF	ON	ON	OFF	ON
179	ON	ON	OFF	OFF	ON	ON	OFF	ON
180	OFF	OFF	ON	OFF	ON	ON	OFF	ON
181	ON	OFF	ON	OFF	ON	ON	OFF	ON
182	OFF	ON	ON	OFF	ON	ON	OFF	ON
183	ON	ON	ON	OFF	ON	ON	OFF	ON
184	OFF	OFF	OFF	ON	ON	ON	OFF	ON
185	ON	OFF	OFF	ON	ON	ON	OFF	ON
186	OFF	ON	OFF	ON	ON	ON	OFF	ON
187	ON	ON	OFF	ON	ON	ON	OFF	ON
188	OFF	OFF	ON	ON	ON	ON	OFF	ON
189	ON	OFF	ON	ON	ON	ON	OFF	ON
190	OFF	ON	ON	ON	ON	ON	OFF	ON
191	ON	ON	ON	ON	ON	ON	OFF	ON
192	OFF	OFF	OFF	OFF	OFF	OFF	ON	ON
193	ON	OFF	OFF	OFF	OFF	OFF	ON	ON
194	OFF	ON	OFF	OFF	OFF	OFF	ON	ON
195	ON	ON	OFF	OFF	OFF	OFF	ON	ON
196	OFF	OFF	ON	OFF	OFF	OFF	ON	ON
197	ON	OFF	ON	OFF	OFF	OFF	ON	ON
198	OFF	ON	ON	OFF	OFF	OFF	ON	ON

ANNEX: DIP SWITCH – CAMERA ADDRESS

199	ON	ON	ON	OFF	OFF	OFF	ON	ON
200	OFF	OFF	OFF	ON	OFF	OFF	ON	ON
201	ON	OFF	OFF	ON	OFF	OFF	ON	ON
202	OFF	ON	OFF	ON	OFF	OFF	ON	ON
203	ON	ON	OFF	ON	OFF	OFF	ON	ON
204	OFF	OFF	ON	ON	OFF	OFF	ON	ON
205	ON	OFF	ON	ON	OFF	OFF	ON	ON
206	OFF	ON	ON	ON	OFF	OFF	ON	ON
207	ON	ON	ON	ON	OFF	OFF	ON	ON
208	OFF	OFF	OFF	OFF	ON	OFF	ON	ON
209	ON	OFF	OFF	OFF	ON	OFF	ON	ON
210	OFF	ON	OFF	OFF	ON	OFF	ON	ON
211	ON	ON	OFF	OFF	ON	OFF	ON	ON
212	OFF	OFF	ON	OFF	ON	OFF	ON	ON
213	ON	OFF	ON	OFF	ON	OFF	ON	ON
214	OFF	ON	ON	OFF	ON	OFF	ON	ON
215	ON	ON	ON	OFF	ON	OFF	ON	ON
216	OFF	OFF	OFF	ON	ON	OFF	ON	ON
217	ON	OFF	OFF	ON	ON	OFF	ON	ON
218	OFF	ON	OFF	ON	ON	OFF	ON	ON
219	ON	ON	OFF	ON	ON	OFF	ON	ON
220	OFF	OFF	ON	ON	ON	OFF	ON	ON
221	ON	OFF	ON	ON	ON	OFF	ON	ON
222	OFF	ON	ON	ON	ON	OFF	ON	ON
223	ON	ON	ON	ON	ON	OFF	ON	ON
224	OFF	OFF	OFF	OFF	OFF	ON	ON	ON
225	ON	OFF	OFF	OFF	OFF	ON	ON	ON
226	OFF	ON	OFF	OFF	OFF	ON	ON	ON
227	ON	ON	OFF	OFF	OFF	ON	ON	ON
228	OFF	OFF	ON	OFF	OFF	ON	ON	ON
229	ON	OFF	ON	OFF	OFF	ON	ON	ON
230	OFF	ON	ON	OFF	OFF	ON	ON	ON
231	ON	ON	ON	OFF	OFF	ON	ON	ON
232	OFF	OFF	OFF	ON	OFF	ON	ON	ON
233	ON	OFF	OFF	ON	OFF	ON	ON	ON
234	OFF	ON	OFF	ON	OFF	ON	ON	ON
235	ON	ON	OFF	ON	OFF	ON	ON	ON
236	OFF	OFF	ON	ON	OFF	ON	ON	ON
237	ON	OFF	ON	ON	OFF	ON	ON	ON
238	OFF	ON	ON	ON	OFF	ON	ON	ON

ANNEX: DIP SWITCH – CAMERA ADDRESS

239	ON	ON	ON	ON	OFF	ON	ON	ON
240	OFF	OFF	OFF	OFF	ON	ON	ON	ON
241	ON	OFF	OFF	OFF	ON	ON	ON	ON
242	OFF	ON	OFF	OFF	ON	ON	ON	ON
243	ON	ON	OFF	OFF	ON	ON	ON	ON
244	OFF	OFF	ON	OFF	ON	ON	ON	ON
245	ON	OFF	ON	OFF	ON	ON	ON	ON
246	OFF	ON	ON	OFF	ON	ON	ON	ON
247	ON	ON	ON	OFF	ON	ON	ON	ON
248	OFF	OFF	OFF	ON	ON	ON	ON	ON
249	ON	OFF	OFF	ON	ON	ON	ON	ON
250	OFF	ON	OFF	ON	ON	ON	ON	ON
251	ON	ON	OFF	ON	ON	ON	ON	ON
252	OFF	OFF	ON	ON	ON	ON	ON	ON
253	ON	OFF	ON	ON	ON	ON	ON	ON
254	OFF	ON	ON	ON	ON	ON	ON	ON
255	ON	ON	ON	ON	ON	ON	ON	ON

Table 4: DIP Switch – Camera Address

Modification History

Revision	Date of Release	Modified Contents
Ver 1.0	Oct 1 st 2016	Official release of first version